

## Peristaltic Industrial Hose Pump

Spare parts list

Dura 05-35 Spare Parts List

Version 5.2v-12/2015  
Print No. 01

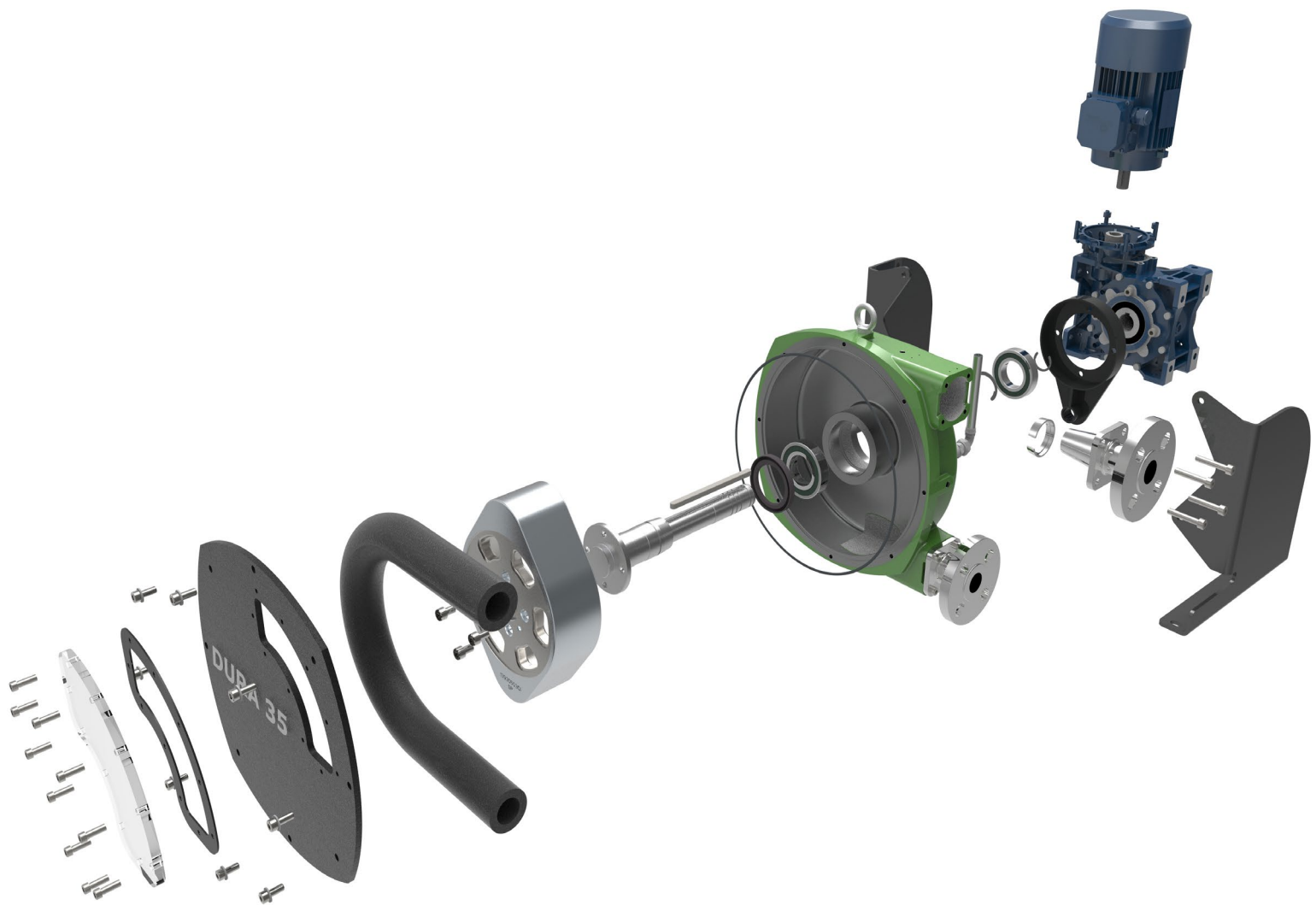



### Dura 05 - 35 Spare Parts List

Table 1 contains a list of spares to help maintain and repair the Dura 05 – 35 peristaltic pumps. Your Verder distributor will be able to advise you where genuine Verderflex® spares can be purchased.

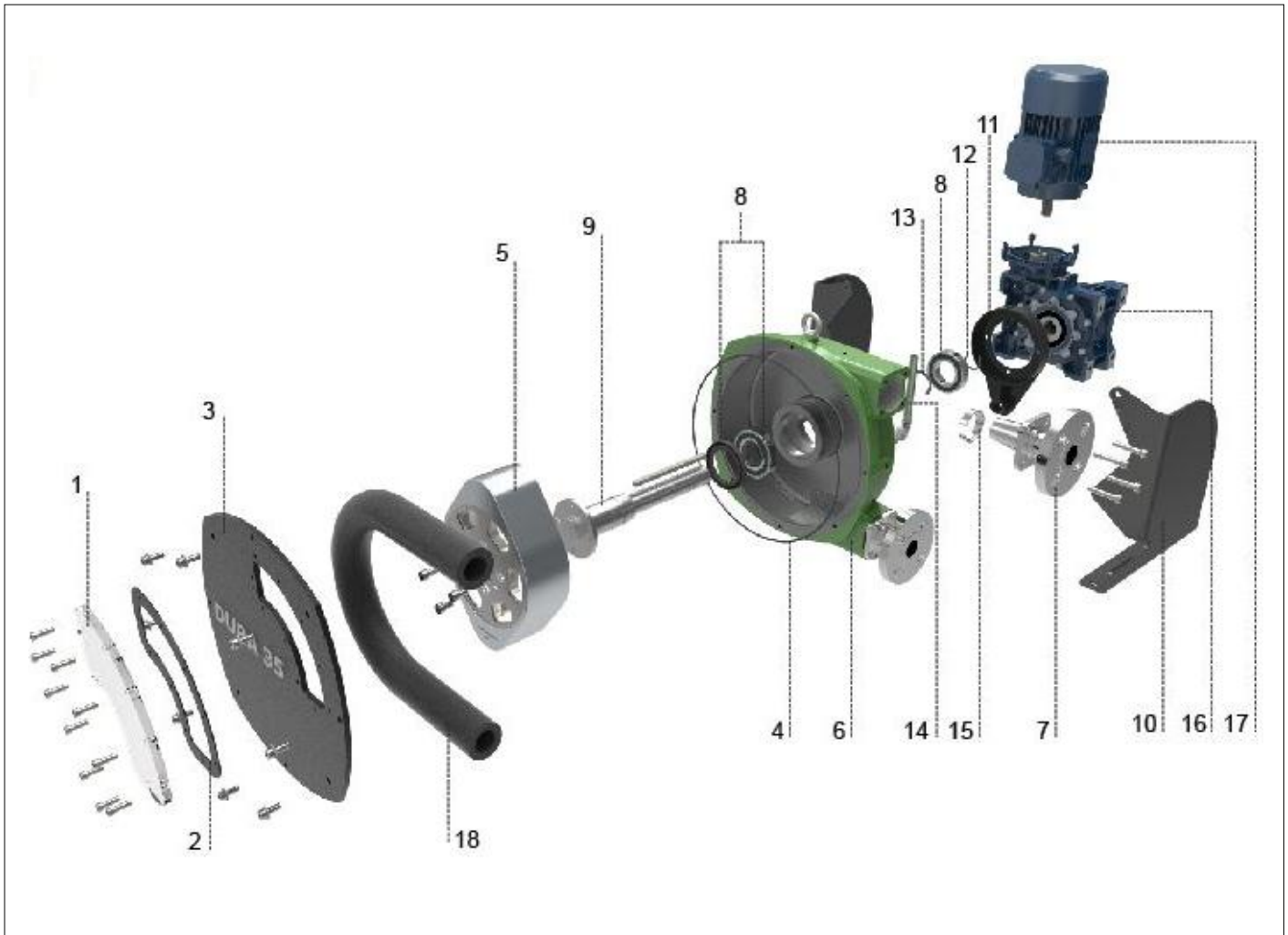

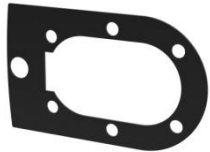





Figure 2 Layout (generic view)

1	Inspection window	7	Port flange	13	Crescent clip (small)
2	Inspection window gasket	8	Shaft mounting kit	14	Filler tube
3	Front cover	9	Drive shaft	15	Clamp Ring*
4	O-ring	10	Frames	16	Gearbox
5	Rotor	11	Torque arm	17	Motor
6	Casing	12	Crescent clip (large)	18	Hose





\* Applies only for D5, D7, D10 and D35.

Table1 Dura 05 - 35 Spare Parts List



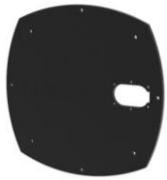

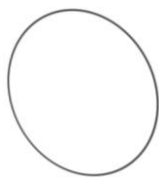
Ref	Item	Part No		Qty	Image
1.	<b>Front cover Inspection window</b>  Type: S1	D 5	139.1321.PA	1	
		D 7	139.1321.PA		
		D10	139.1321.PA		
		D15	139.1322.PA		
		D25	139.1323.PA		
		D35	139.1324.PA		
	<b>Front cover Inspection window</b>  Type: S2	D 5	139.2221.P	1	
		D 7	139.2221.P		
		D10	139.2221.P		
		D15	139.2222.P		
		D25	139.2223.P		
		D35	139.2224.P		
2.	<b>Front cover Inspection window gasket</b>  Type: S1	D 5	139.1234	1	
		D 7	139.1234		
		D10	139.1234		
		D15	139.1235		
		D25	139.1236		
		D35	139.1233		
	<b>Front cover Inspection window gasket</b>  Type: S2	D 5	139.2237	1	
		D 7	139.2237		
		D10	139.2237		
		D15	139.2235		
		D25	139.2236		
		D35	139.2233		
*2.	<b>Front cover Inspection window and gasket assembly</b>  Type: S2	D 5	139.2221.PA	1	
		D 7	139.2221.PA		
		D10	139.2221.PA		
		D15	139.2222.PA		
		D25	139.2223.PA		
		D35	139.2224.PA		
	<b>Front cover Inspection window For ATEX rated pumps</b>	D 5	-	1	
		D 7	-		
		D10	-		
		D15	000892		
		D25	-		
		D35	-		

\*Optional available on special request

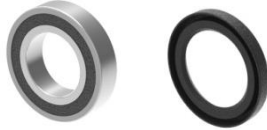
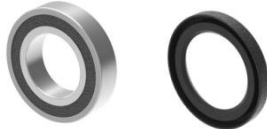



Table1 Dura 05 - 35 Spare Parts List (continued)

Ref	Item		Part No		Qty	Image					
3.	Front cover Type: S1		D 5	139.0039.S	1						
			D 7	139.0039.S							
			D10	139.0039.S							
			D15	139.0040.S							
			D25	139.0041.S							
			D35	139.0042							
	Front cover Inspection window Type: S2		D 5	139.0139.S	1						
			D 7	139.0139.S							
			D10	139.0139.S							
			D15	139.0140.S							
			D25	139.0141.S							
			D35	139.0142							
4.	Front cover O-ring		D 5	139.0075	1						
			D 7	139.0075							
			D10	139.0075							
			D15	139.0076							
			D25	139.0077							
			D35	139.0078							
5.	Rotor assembly  CI – Cast iron option	Standard Rotor	D 5	139.2116.3.CI	1						
			D 7	139.2116.3.CI							
			D10	139.2117.3.CI 139.2117.3							
			D15	139.2369.3.CI 139.2369.3							
			D25	139.2049.3.CI							
			D35	139.3050.3.CI							
		High Pressure Rotor	D 5	139.2116.CI							
			D 7	139.2116.CI							
			D10	139.2117 139.2117.CI							
			D15	139.2369 139.2369.CI							
			D25	139.2049.CI							
			D35	139.3050.CI							
			7.	1 Piece flange			SS	D 5	Not available	1	
							PP		Not available		
PVDF	Not available										
SS	D 7	Not available									
PP		Not available									
PVDF		Not available									
SS	D10	139.1334.A									
PP		obsolete									
PVDF		obsolete									





**Table1 Dura 05 - 35 Spare Parts List (continued)**

Ref	Item	Part No	Qty	Image	
7.	<b>Standard flange</b> <i>(1 piece)</i>	SS	D15	139.1335.A	
		PP		<i>obsolete</i>	
		PVDF		<i>obsolete</i>	
		SS	D25	139.1336.A	
		PP		<i>obsolete</i>	
		PVDF		<i>obsolete</i>	
		SS	D35	139.1337.A	
		PP		<i>Not available</i>	
PVDF	<i>Not available</i>				
7.1	<b>Split flange (option)</b>	D 5		139.1334.B	
		D 7		139.1334.B	
		D10		139.1334.B	
		D15		139.1335.B	
		D25		139.1336.B	
		D35		139.1337.B	
	<b>Split flange insert</b>	SS	D 5	139.2154	
		PP		139.2152	
		PVDF		139.2153	
		SS	D 7	139.2174	
		PP		139.2172	
		PVDF		139.2173	
		PP	D10	139.2102	
		PVDF		139.2103	
		PP	D15	139.2132	
		PVDF		139.2133	
		PP	D25	139.2142	
		PVDF		139.2143	
PP	D35	139.2182			
PVDF		139.2183			
7.2	<b>Split flange assembly with insert</b>	SS	D 5	139.2254	
		PP		139.2252	
		PVDF		139.2253	
		SS	D 7	139.2274	
		PP		139.2272	
		PVDF		139.2273	
		PP	D10	139.2202	
		PVDF		139.2203	
		PP	D15	139.2238	
		PVDF		139.2240	
		PP	D25	139.2232	
		PVDF		139.2243	
		PP	D35	139.2281	
		PVDF		139.2283	

**Table1 Dura 05 - 35 Spare Parts List (continued)**







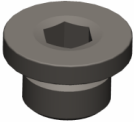

Ref	Item	Part No	Qty	Image		
7.3	<b>Hose tail assembly C/W fasteners</b>	D05	-	1		
		D07	-			
		D10	139.1334.H			
		D15	139.1335.H			
		D25	-			
		D35	-			
8.	<b>Shaft Mounting Kit</b> <i>Comprising: Bearings and Viton Lip seal</i>	D 5	139.1450.VT	1		
		D 7	139.1450.VT			
		D10	139.1450.VT			
		D15	139.1451.VT			
		D25	139.1452.VT			
		D35	139.1453.VT			
	<b>Shaft Mounting Kit</b> <i>Comprising: Bearings and PFTE Lip seal</i>	D 5	139.1450.PT	1		
		D 7	139.1450.PT			
		D10	139.1450.PT			
		D15	139.1451.PT			
		D25	139.1452.PT			
		D35	-			
9.	<b>Drive shaft</b>	D 5	139.1554	1		
		D 7	139.1554			
		D10	139.1554			
		D15	139.1559			
		D25	139.1160			
		D35	139.1261			
10.	<b>Frames</b>	D 5	139.2314.A	1		
		D 7	139.2314.A			
		D10	139.2314.A			
		D15	139.2315.A			
		D25	139.2326.A			
		D35	139.2327.A			
11.	<b>Torque arm</b>	Standard	D 5	139.1210.A	1	
			D 7	139.1210.A		
			D10	139.1210.A		
			D15	139.1220.A		
			D25	139.1230.A		
		D35	NMRVP90	139.1240.A		
			SK92672	139.1340.A		
			SK1SI75	139.1440.A		
			A352/W86	139.1540.A		

**Table1 Dura 05 - 35 Spare Parts List (continued)**



Ref	Item	Part No		Qty	Image	
12.	Crescent clip (large)	D 5	139.7030.50	1		
		D 7	139.7030.50			
		D10	139.7030.50			
		D15	139.7031.50			
		D25	139.7032.50			
		D35	139.7033.25			
13.	Crescent clip (small)	D 5	139.7060.50	1		
		D 7	139.7060.50			
		D10	139.7060.50			
		D15	139.7061.50			
		D25	139.7061.50			
		D35	139.7031.50			
14.	Filler tube	D 5	139.0759.D	1		
		D 7	139.0759.D			
		D10	139.0759.D			
		D15	139.0759.D			
		D25	139.0760			
		D35	139.0761			
14.1	Plastic filler tube	D 5	-	1		
		D 7	-			
		D10	-			
		D15	139.0859			
		D25	139.0860			
		D35	139.0860			
15.	Clamp Ring (Supplied as Flange sealing kit)	Single	D 5	139.2101	1	
		Pack of 5		139.2105		
		Single	D 7	139.2101		
		Pack of 5		139.2105		
		Single	D10	139.2101		
		Pack of 5		139.2105		
		Single	D15	-		
		Pack of 5		-		
		Single	D25	-		
		Pack of 5		-		
Pair	D35	139.1045				



**Table 2: Parts for reference (not supplied as spares by Verderflex)**

Item	Pump model		Image
<b>Drain plugs</b>	D 5, 7, 10, 15, 25, 35	1/8" BSPP Brass Nickel Plated	
<b>Mounting frame fasteners</b>	D 5, 7, 10, 15	M8 x 12 – 8.8 Steel BZP	
	D 25	M8 x 12 – 8.8 Steel BZP	
	D 35	M10 x 16 – 12.9 Steel BZP	
<b>Rotor screws</b>	D 5, 7, 10, 15	M6 x 12 – 10.9 Steel BZP CS	
	D 25	M8 x 15 Steel BZP CS	
	D 35	M10 x 20 Steel BZP CS	
<b>Front cover screws</b>	D 5, 7, 10, 15	M6 x 16 – 8.8 Steel BZP	
	D 25	M8 x 16 – 12.9 Steel BZP	
	D 35	M8 x 20 – 12.9 Steel BZP	
<b>Torque arm bolt</b>	D 5, 7, 10	M6 x 8 x 30 Socket Head Shoulder 12.9	
	D 15	M6 x 8 x 30 Socket Head Shoulder 12.9	
	D 25	M8 x 10 x 40 Socket Head Shoulder 12.9	
	D 35	M10 x 50 Socket Head Shoulder 8.8	
<b>Port flange screws</b>	D 5, 7, 10, 15	M6 x 30 – 12.9 Steel BZP	
	D 25	M8 x 45 – 12.9 Steel BZP	
	D 35	M8 x 45 – 12.9 Steel BZP	
<b>Inspection window screws</b>	D 5, 7, 10, 15	M6 x 12 – 8.8 Steel BZP	
	D 25	M6 x 20 – 8.8 Steel BZP	
	D 35	M6 x 20 – 8.8 Steel BZP	
<b>Spring washer</b>	D 5, 7, 10, 15, 25, 35	M8 Bright Zinc Plate Steel	

**Table 3: Accessories**

Item	Pump model	P/N	Image
<b>Revolution sensor</b>	D 5, 7, 10, 15, 25, 35	129.0805	
<b>Hose burst detection kit for standard filler tube</b>	D 5, 7, 10, 15, 25, 35	129.0719	
<b>Hose burst detection kit for Plastic filler tube</b>	D 5	-	
	D 7	-	
	D10	-	
	D15	139.0859.HB	
	D25	139.0860.HB	
	D35	139.0860.HB	

**Table 4: Hose options**

Item Description		Part No		Qty	Image
<b>Hose option</b> <i>NR/White</i>	singles	D 5	139.2080	1	
		D 7	139.2085		
		D10	139.0001		
		D15	139.0002		
		D25	139.0003		
		D35	139.0004		
<b>Hose option</b> <i>NBR/Yellow</i>	singles	D 5	139.2082	1	
		D 7	139.2087		
		D10	139.0512		
		D15	139.0513		
		D25	139.0514		
		D35	139.0515		
<b>Hose option</b> <i>NBRF/Yellow + White</i>	singles	D 5	-	1	
		D 7	-		
		D10	139.2021		
		D15	139.2022		
		D25	139.2023		
		D35	139.2024		
<b>Hose option</b> <i>Hypalon® /Green</i>	singles	D 5	139.2081	1	
		D 7	139.2086		
		D10	139.2010		
		D15	139.2011		
		D25	139.2012		
		D35	139.2013		
<b>Hose option</b> <i>EPDM/Red</i>	singles	D 5	-	1	
		D 7	-		
		D10	139.0010		
		D15	139.0011		
		D25	139.0012		
		D35	139.0013		
<b>Hose option</b> <i>Verderprene option/White</i>	singles	D 5	139.2030	1	
		D 7	-		
		D10	139.2031		
		D15	139.2032		
		D25	139.2033		
		D35	139.2034		

**Table 5: Pump Lubricants**

The pump must always be filled with the correct amount of lubricant to the middle level marks of the front cover. Table 5 shows the standard amount of lubricant supplied with Dura pumps in litres and US gallons.

Pump size	Lubricant	Standard Quantity Supplied with Pump in Litre (US Gallons)	Part Number
<b>Dura 05</b>	Verderlube® VerderSil®	0.5 (0.1)	129.1418 129.1372
<b>Dura 07</b>	Verderlube® VerderSil®	0.5 (0.1)	129.1418 129.1372
<b>Dura 10</b>	Verderlube® VerderSil®	0.5 (0.1)	129.1418 129.1372
<b>Dura 15</b>	Verderlube® VerderSil®	0.5 (0.1)	129.1418 129.1372
<b>Dura 25</b>	Verderlube® VerderSil®	2.0 (0.5)	129.1419 (Qty.2) 129.1373 (Qty.2)
<b>Dura 35</b>	Verderlube® VerderSil®	2.5 (0.7)	129.2379 129.2505