

m&h NC GAGE

THE INNOVATIVE GAUGING APP FOR MACHINE TOOLS





m&h NC GAGE – SIMPLE AND QUICK FOR MACHINING CENTERS AND MILL-TURN MACHINES

m&h NC Gage revolutionises probing on machine tools. The simple use, and innovative “Teach-in” process allow a user to create gauging programs without previous programming knowledge, even on 5 axis machines and mill-turn machines. m&h NC Gage uses the same PTB-Certified algorithms used by coordinate measuring machines. This allows NC Gage to bring the highest precision to machines, and to establish trust in manufacturing processes. Measurement is not limited to specific numbers of points or 2D features. Also distances, angles between features and basic GD&T functions are available.

As part of m&h Connected Probing, NC Gage enables using measuring results for several types of automatic data operations:

- Setting and updating work offsets
- Setting and updating tool geometry and wear
- Feeding values back to variables in a cutting program
- Sending critical feature data to statistical processes

ADVANTAGES:

- Quick, Intuitive usage with “Teach-In” function
- Simple creation of 5 Axis and Mill-turn gauging programs
- More functionalities and simpler application than complicated macro programs

HIGHLIGHTS:

NC Gage is designed for use on modern mill-turn machines and supports, for instance, aligning the C-Axis using flats, keys and keyways.

Simple checks of form and position are possible in-process. Use a probe with NC Gage to check roundness, flatness, straightness, squareness, parallelism, concentricity and position.

Use any number of functions for measurement and automatic part setup. For instance: Bores, Constructed Points, or Mid-points.

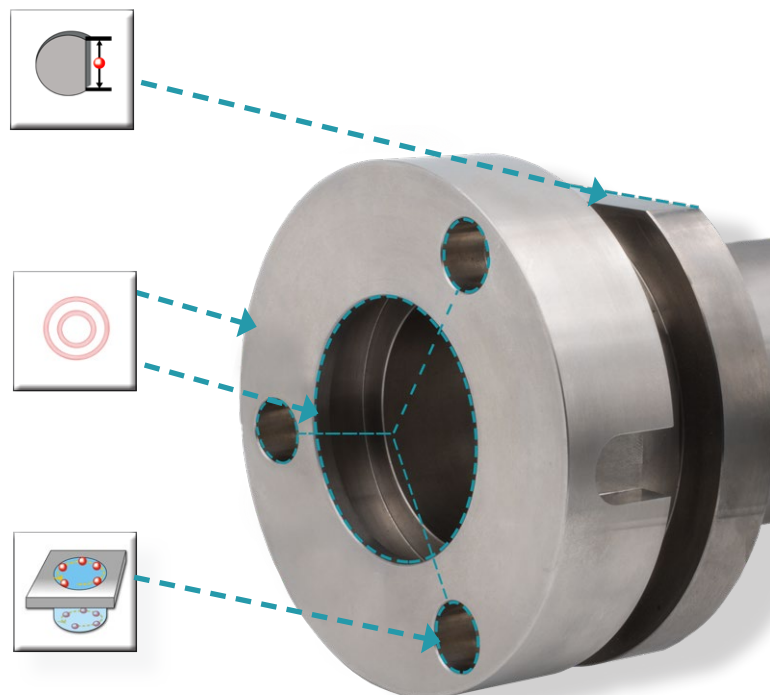

TEACH-IN

THE WAY TO GAUGING – WITHOUT PROGRAMMING MACROS

m&h NC Gage's unique "Teach-In" function simplifies creating gauging programs by eliminating the need to create macro programs. The operator is guided visually, step-by-step in adding measurements to a gauging program. In this way, even complex gauging cycles can be developed, completely without any macro or programming know-how. NC Gage makes using a probe and creating 5-axis gauging cycles easier than ever.

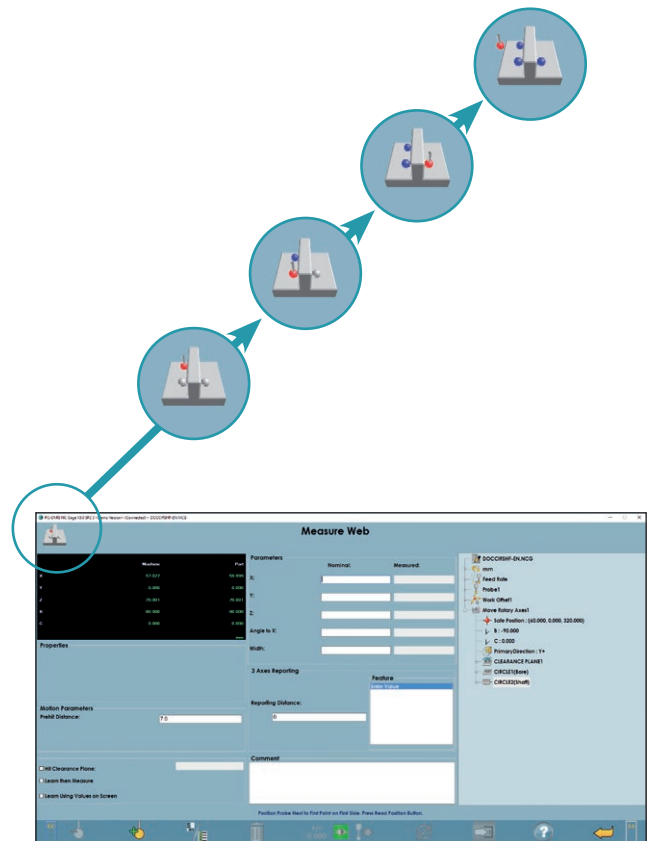

MEASURING ON 5-AXIS MACHINES (Option)

MAKING 5 AXIS GAUGING SIMPLE

Effective use of 5 axis machines requires quick measurement and setup of workpieces. This is easier than ever with m&h NC Gage, regardless of which 5 axis kinematic-type is used for machining and measuring. NC Gage can be used on machines with rotary tables, 3+1 and 3+2 machines, 5 Axis machining centers, Multitasking machines and other machines with rotation axes. One thing remains common across all machine types: the same simple operation for the machinist with no complicated macro programming.

MEASURING ON MILL-TURN MACHINES

THE UNIQUE GAUGING SOLUTION FOR MILL-TURN MACHINES

m&h NC Gage is designed for use on modern mill-turn machines and supporting challenging machining tasks. Special functions simplify adding fully automated gauging, setup and inspection to multi-spindle processes. For instance, perform fully automated loading by aligning the C-Axis using flats, keys and keyways, feedback critical dimensions into processes, quick-check basic GD&T for quality, or ensure proper machining after switching to the second spindle.

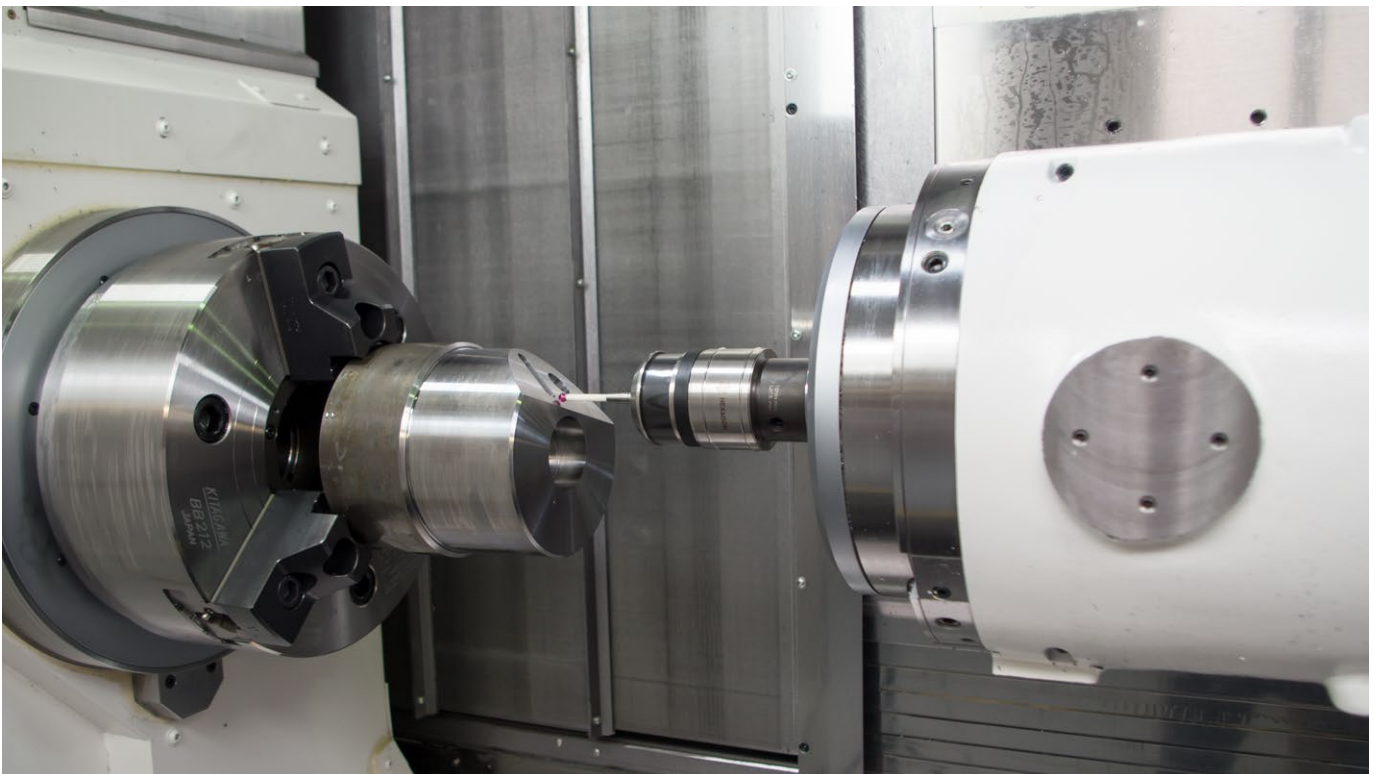

CHECKSET5 (Option)

KEEPING 5 AXIS KINEMATICS IN CHECK

Quickly identify and easily correct kinematic errors. The option CheckSet5 offers the possibility to analyse the motion of the rotation axes on 4 and 5 axis milling machines. The resulting data presents a detailed overview of the machine's condition and also delivers correction values for the rotary axis rotation centers.

As part of m&h NC Gage, CheckSet5 also makes use of "Teach-In" operation to allow rapid and flexible setup of all checks, and eliminates having to create or modify special macro programs.

REPORTS AND STATISTICAL EVALUATION

MEANINGFUL REPORTS FOR QUALITY DATA, STATISTICS-READY

m&h NC Gage produces clear and concise measurement reports similar to those from a CMM. Color-coded results for in/out of tolerance as well as a simple tolerance overview scale provides the operator with the information needed at a glance, to support quality in production. The report can be saved automatically or printed, and serves as documentation of the quality produced. A statistics interface is also included allowing output to Q-DAS, Excel and XML.

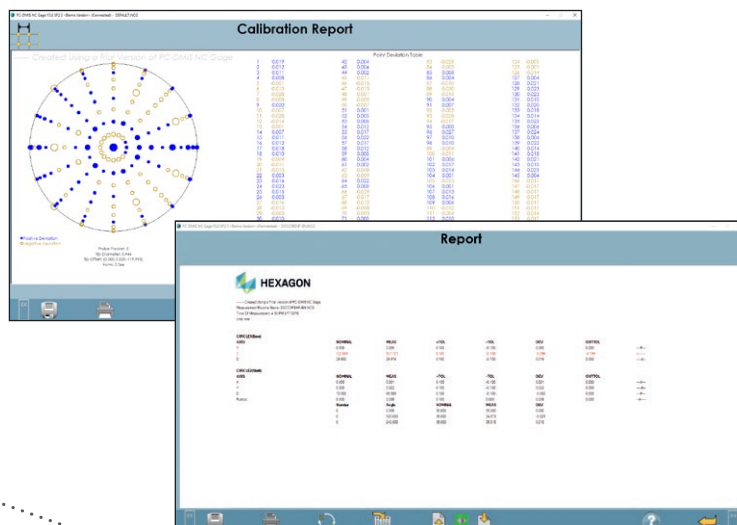

m&h NC GAGE

STANDARD MEASURING FEATURES

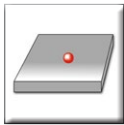

Point

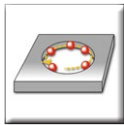

Bore

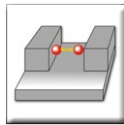

Pocket

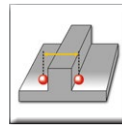

Web

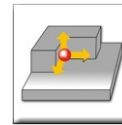

Corner (inner)

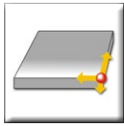

Corner (outer)

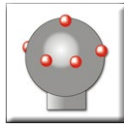

Sphere

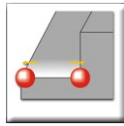

Line

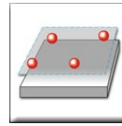

Flat

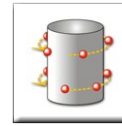

Cylinder (outer)

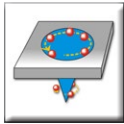

Cone (inner)

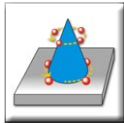

Cone (outer)

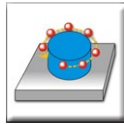

Boss

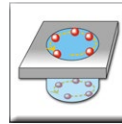

Cylinder (inner)

DESIGN-FUNCTIONS

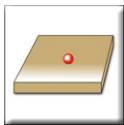

Point



Line

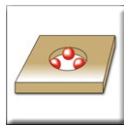

Circle

CHECKING FORM AND POSITION



Angle



Perpendicularity

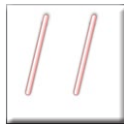

Parallelism



Concentricity

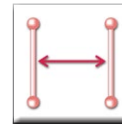

Distance

SETTING ZERO POINTS AND VARIABLES



Set zero point



Update zero point



Set variable

FUNCTIONS IN TURN-MILL MACHINES

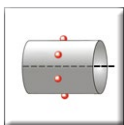

Shaft

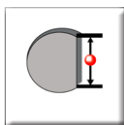

Flat

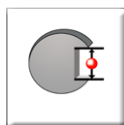

Keyway

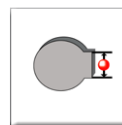

Key





HEXAGON

MANUFACTURING INTELLIGENCE

Hexagon Manufacturing Intelligence helps industrial manufacturers develop the disruptive technologies of today and the life-changing products of tomorrow. As a leading metrology and manufacturing solution specialist, our expertise in sensing, thinking and acting – the collection, analysis and active use of measurement data – gives our customers the confidence to increase production speed and accelerate productivity while enhancing product quality.

Through a network of local service centres, production facilities and commercial operations across five continents, we are shaping smart change in manufacturing to build a world where quality drives productivity. For more information, visit HexagonMI.com.

Hexagon Manufacturing Intelligence is part of Hexagon (Nasdaq Stockholm: HEXA B; hexagon.com), a leading global provider of information technologies that drive quality and productivity across geospatial and industrial enterprise applications.

-  COORDINATE MEASURING MACHINES
-  3D LASER SCANNING
-  SENSORS
-  PORTABLE MEASURING ARMS
-  SERVICES
-  LASER TRACKERS & STATIONS
-  MULTISENSOR & OPTICAL SYSTEMS
-  WHITE LIGHT SCANNERS
-  METROLOGY SOFTWARE SOLUTIONS
-  CAD / CAM
-  STATISTICAL PROCESS CONTROL
-  AUTOMATED APPLICATIONS
-  MICROMETERS, CALIPERS AND GAUGES

m&h Inprocess Messtechnik GmbH
sales.mh@hexagon.com
www.mh-inprocess.com