

RG

MATERIALS

Diffusor:
Zinc plated steel

Element support:
Polyamide
(aluminium alloy for FRG3+ & 4+)

Magnetic core:
Synthesized magnetic material

Seals:
NBR Nitrile
(FKM - on request fluoroelastomer)

PRESSURE (ISO 10771-1:2002)

Collapse, differential
for the filter element (ISO 2941):
1 MPa (10 bar)

BYPASS VALVE

Setting:
170 kPa (1,7 bar) \pm 10%

WORKING TEMPERATURE

From -25° to + 110° C

COMPATIBILITY (ISO 2943)

Full with fluids: HH-HL-HM-HV-HTG
(according to ISO 6743/4)
For fluids different than the above mentio-
ned, please contact our Sales Department.

APPLICATION EXAMPLE

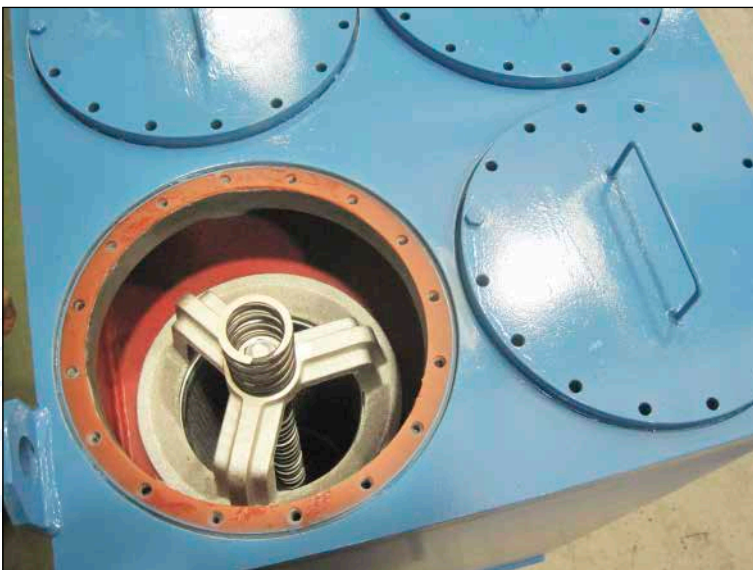

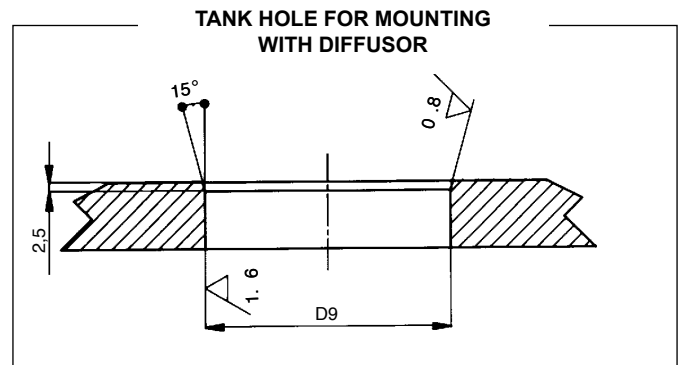
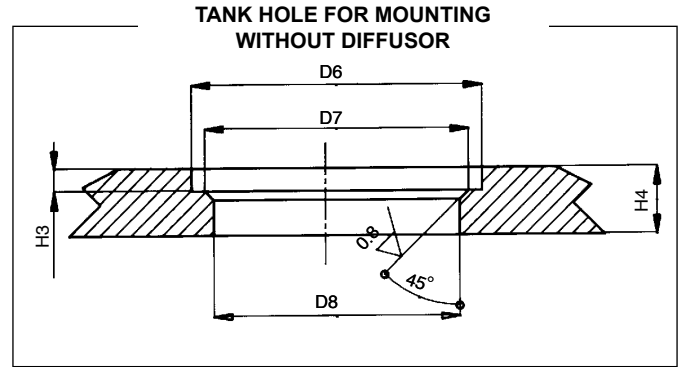
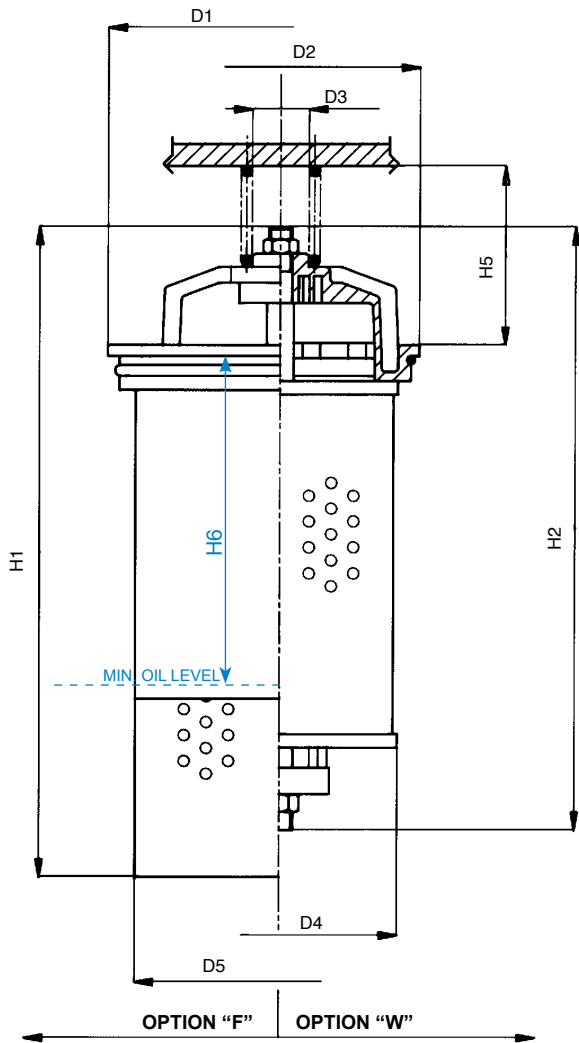

FILTER HOUSING

	D1	D2	D3	D4	D5	D6	D7	D8	D9	H1	H2	H3	H4	H5	H6	kg opt. "F"	kg opt. "W"
FRG11	120	87	20	72	89	88	82,5	76	110	263,5	197	4	12	45	118	1,25	0,70
FRG12	120	87	20	72	89	88	82,5	76	110	263,5	240	4	12	45	118	1,45	0,90
FRG13	120	87	20	72	89	88	82,5	76	110	308,5	290	4	12	45	170	1,65	1,00
FRG14	120	87	20	72	89	88	82,5	76	110	413,5	390	4	12	45	270	2,10	1,30
FRG22	155	125,5	25	106	132	126	123,5	117	145	325	308	5	15	78	150	2,75	1,65
FRG23	155	125,5	25	106	132	126	123,5	117	145	395	378	5	15	78	220	3,20	1,90
FRG24	155	125,5	25	106	132	126	123,5	117	145	600	583	5	15	78	425	4,40	2,50
FRG31	185	150	25	126	165	151	149	139	178	370,5	337	5	18	100	190	3,85	2,25
FRG32	185	150	25	126	165	151	149	139	178	450,5	417	5	18	100	270	4,70	2,80
FRG33	185	150	25	126	165	151	149	139	178	550	517	5	18	100	370	5,60	3,20
FRG34	185	150	25	126	165	151	149	139	178	640	602	5	18	100	460	6,20	3,50
FRG41	260	230	40	203	235	231	227	217	250,5	546	524	6	20	140	205	10,20	7,20
FRG42	260	230	40	203	235	231	227	217	250,5	761	739	6	20	140	420	14,00	9,50
FRG43	260	230	40	203	235	231	227	217	250,5	1041	1019	6	20	140	700	20,00	14,00
FRG44	260	230	40	203	235	231	227	217	250,5	1306	1284	6	20	140	965	26,00	19,00

TYPE																ELEMENT		E			
F = FILTER COMPLETE		F	F	F	F	F	F	F	F	F	F	F	F	F	F	F	F	F			
B = FILTER HOUSING		B	B	B	B	B	B	B	B	B	B	B	B	B	B	B	B	B			
R	G															FAMILY		R	F		
FAMILY, NOMINAL SIZE & LENGTH		11	12	13	14	22	23	24	31	32	33	34	41	42	43	44	SIZE & LENGTH				
T																SEALS					
T = in the tank		T	T	T	T	T	T	T	T	T	T	T	T	T	T	T	T				
0 0																SEALS					
00		00	00	00	00	00	00	00	00	00	00	00	00	00	00	00	00				
F																SEALS					
F = 170 kPa (1,7 bar)		F	F	F	F	F	F	F	F	F	F	F	F	F	F	F	F				
SEALS																SEALS					
N = NBR Nitrile		N	N	N	N	N	N	N	N	N	N	N	N	N	N	N	N			N = NBR	
F = FKM Fluoroelastomer		F	F	F	F	F	F	F	F	F	F	F	F	F	F	F			F = FKM		
FILTER MEDIA																FILTER MEDIA					
FA = fiber 5 μm _(c) β>1.000		FA	FA	FA	FA	FA	FA	FA	FA	FA	FA	FA	FA	FA	FA	FA			FA = fiber 5 μm _(c)		
FB = fiber 7 μm _(c) β>1.000		FB	FB	FB	FB	FB	FB	FB	FB	FB	FB	FB	FB	FB	FB	FB			FB = fiber 7 μm _(c)		
FC = fiber 12 μm _(c) β>1.000		FC	FC	FC	FC	FC	FC	FC	FC	FC	FC	FC	FC	FC	FC	FC			FC = fiber 12 μm _(c)		
FD = fiber 21 μm _(c) β>1.000		FD	FD	FD	FD	FD	FD	FD	FD	FD	FD	FD	FD	FD	FD	FD			FD = fiber 21 μm _(c)		
CC = cellulose 10 μm β>2		CC	CC	CC	CC	CC	CC	CC	CC	CC	CC	CC	CC	CC	CC	CC			CC = cellulose 10 μm		
ME = wire mesh 60 μm		ME	ME	ME	ME	ME	ME	ME	ME	ME	ME	ME	ME	ME	ME	ME			ME = wire mesh 60 μm		
X	X															CLOGGING INDICATOR					
XX = not applicable		XX	XX	XX	XX	XX	XX	XX	XX	XX	XX	XX	XX	XX	XX	XX					
ACCESSORIES																ACCESSORIES					
W = without accessory		W	W	W	W	W	W	W	W	W	W	W	W	W	W	W					
F = with diffusor		F	F	F	F	F	F	F	F	F	F	F	F	F	F	F					
ACCESSORIES																ACCESSORIES					
W = without accessory		W	W	W	W	W	W	W	W	W	W	W	W	W	W	W					
M = magnetic core		M	M	M	M	M	M	M	M	M	M	M	M	M	M	M					

FILTER ELEMENT							
	A	B	C	kg	Area (cm ²)		
					Media F+	Media C+	Media M+
ERF11	45	72	106	0,25	770	1.250	460
ERF12	45	72	150	0,35	1.170	1.800	650
ERF13	45	72	200	0,45	1.570	2.450	880
ERF14	45	72	300	0,60	2.370	3.600	1.320
ERF22	72	106	190	0,75	3.900	4.600	1.500
ERF23	72	106	260	1,00	5.400	6.400	2.050
ERF24	72	106	465	1,50	9.700	11.800	3.670
ERF31	92	126	210	1,15	5.500	6.650	2.250
ERF32	92	126	290	1,50	7.700	9.200	3.150
ERF33	92	126	390	1,90	10.400	12.400	4.250
ERF34	92	126	480	2,20	12.800	15.400	5.250
ERF41	157	203	330	3,90	17.900	22.100	6.400
ERF42	157	203	545	5,20	30.000	37.000	10.800
ERF43	157	203	825	9,00	45.200	55.500	16.200
ERF44	157	203	1.090	13,00	60.000	74.000	21.800

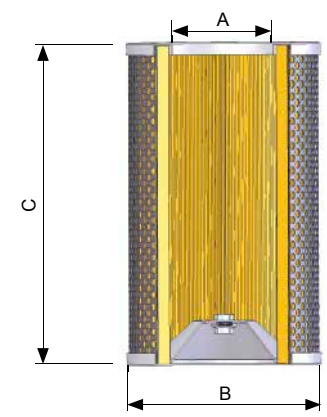

PRESSURE DROP CURVES (Δp)

The "Assembly Pressure Drop (Δp)" must be lower than 50 kPa (0,5 bar).

CLEAN FILTER ELEMENT PRESSURE DROP WITH F+, C+ AND ME MEDIA
(depending both on the internal diameter of the element and on the filter media)

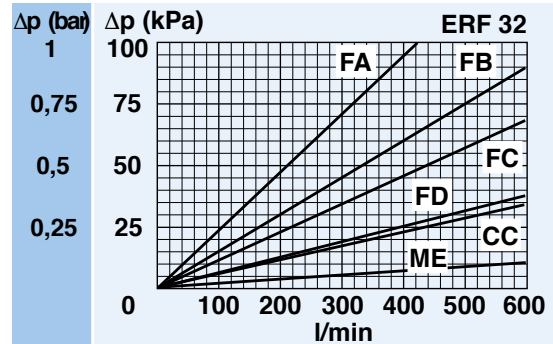
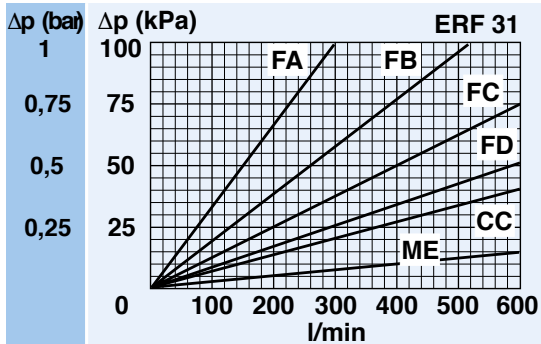
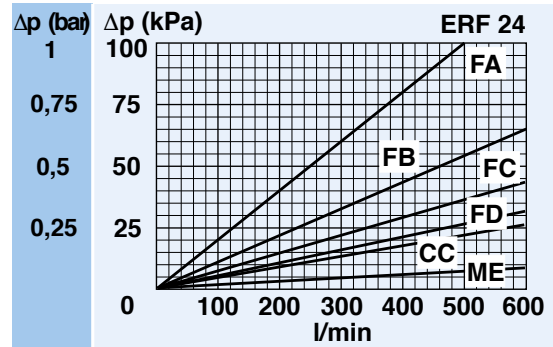
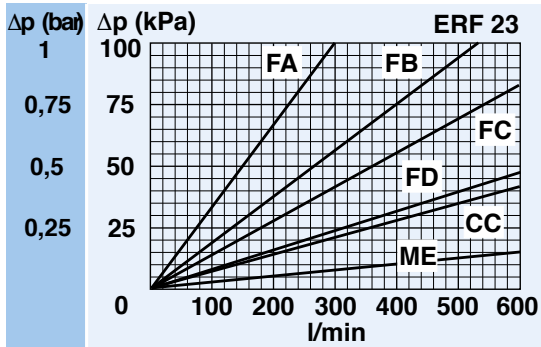
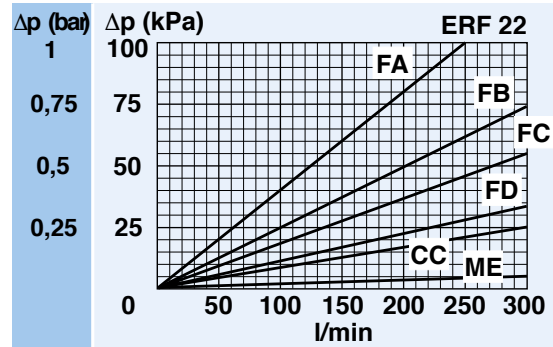
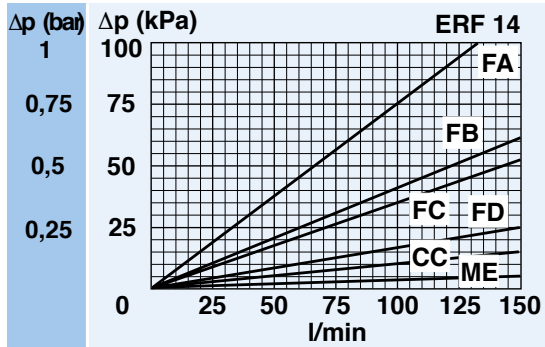
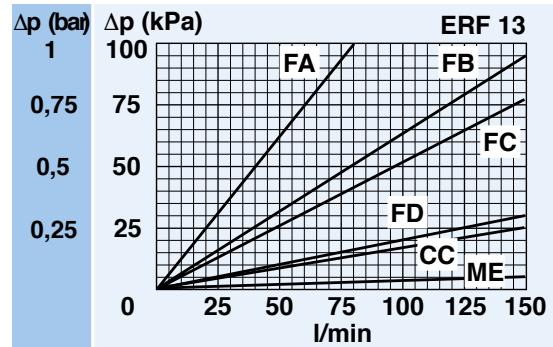
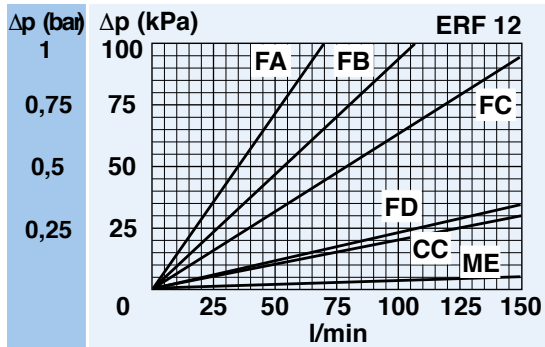
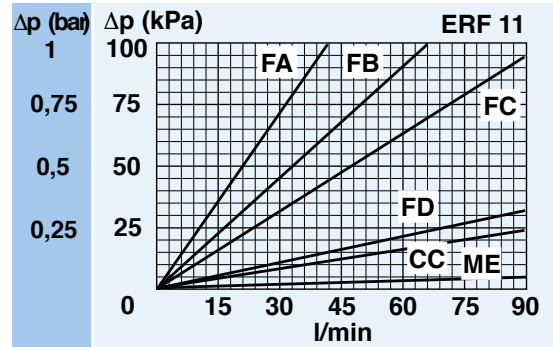

N.B. All the curves have been obtained with mineral oil having a kinematic viscosity 30 cSt and specific gravity 0,9 kg/dm³; for fluids with different features, please consider the factors described in the first part of this catalogue. All the curves are obtained from test done at the UFI HYDRAULIC DIVISION Laboratory, according to the specification ISO 3968. In case of discrepancy, please check the contamination level, viscosity and features of the fluid in use.

CLEAN FILTER ELEMENT PRESSURE DROP WITH F+, C+ AND ME MEDIA
 (depending both on the internal diameter of the element and on the filter media)

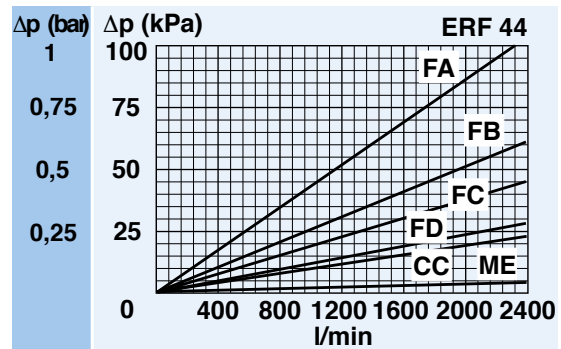
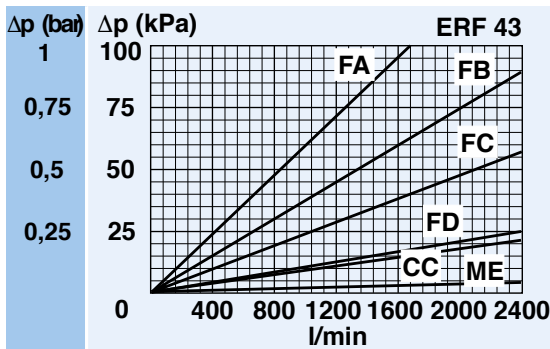
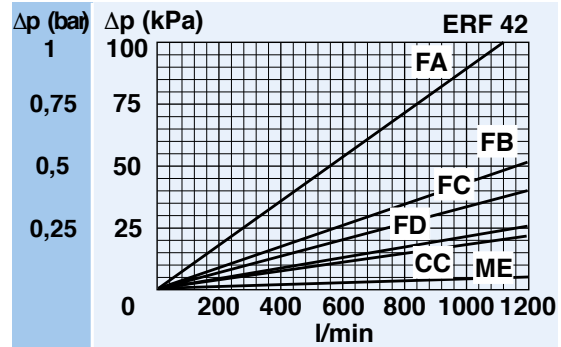
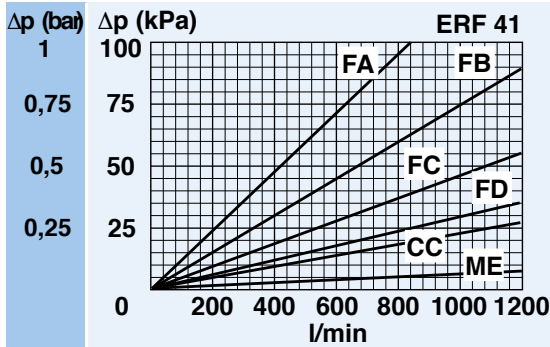
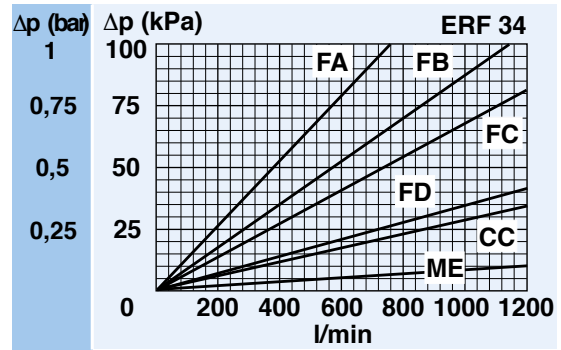
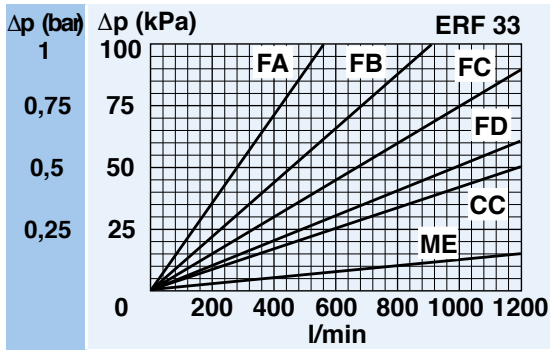

BYPASS VALVE PRESSURE DROP

When selecting the filter size, these curves must be taken into account if it is foreseen that any flow peak is to be absorbed by the bypass valve, it also must be of proper configuration to avoid pressure peaks. The valve pressure drop is directly proportional to fluid specific gravity.

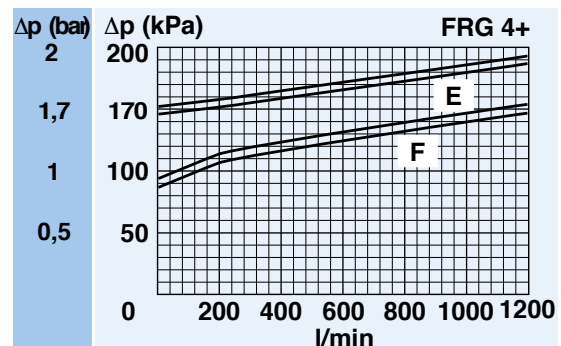
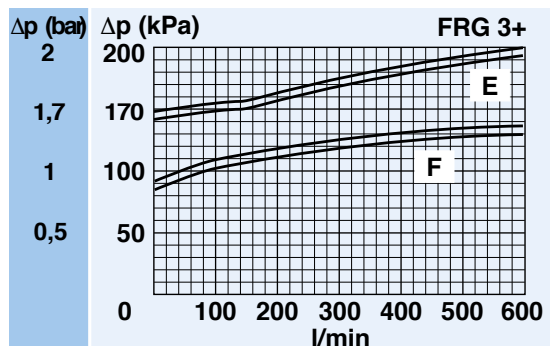
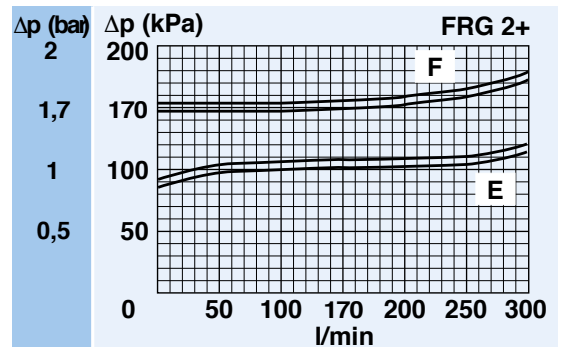
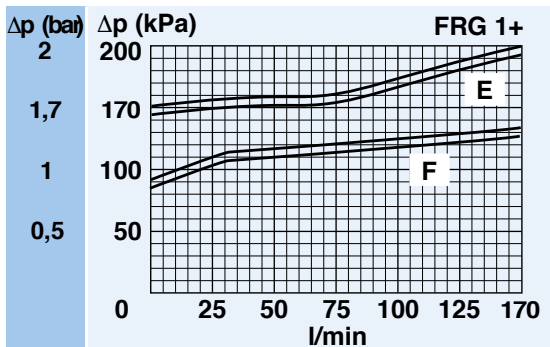

MAGNETIC CORE

The magnetic core (available as an option) ensures a magnetic pre-filtration of ferrous particles, even during bypass conditions.

DIFFUSOR

The diffuser (available as an option) smooths the oil flow thus reducing turbulence inside the tank even in case of large flow rates.

BYPASS

The bypass function is obtained by the filter element moving axially, in such a way that the contaminant is retained in the filter element during bypass conditions.

CUSTOMIZED MOUNTING

The RG series filter inserts have been designed to be mounted in custom-made housings inside the reservoir, providing low cost filtration solutions and solving specific assembly requirements.

INSIDE TO OUTSIDE FILTRATION

“Inside-to-outside” filtration ensures the contaminant is retained inside the element during replacement; also filling or top-up of the reservoir can be done through the filter thus avoiding the ingress of new contaminant.

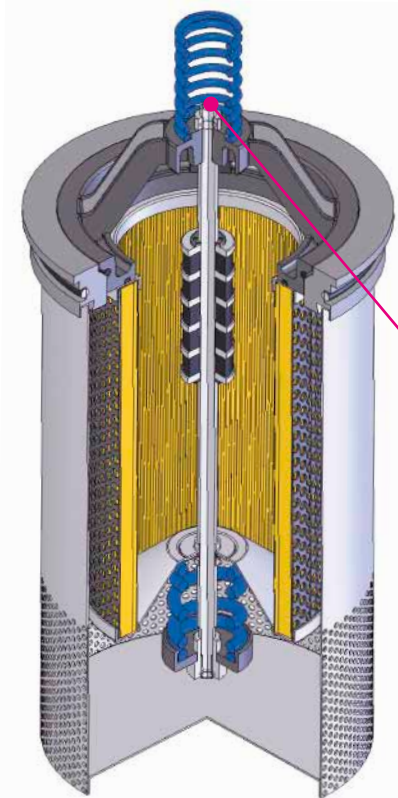

SPARE SEAL KIT

	NBR	FKM
FRG11	521.0063.2	521.0067.2
FRG12	521.0063.2	521.0067.2
FRG13	521.0063.2	521.0067.2
FRG14	521.0063.2	521.0067.2
FRG22	521.0064.2	521.0068.2
FRG23	521.0064.2	521.0068.2
FRG24	521.0064.2	521.0068.2
FRG31	521.0065.2	521.0069.2
FRG32	521.0065.2	521.0069.2
FRG33	521.0065.2	521.0069.2
FRG34	521.0065.2	521.0069.2
FRG41	521.0066.2	521.0070.2
FRG42	521.0066.2	521.0070.2
FRG43	521.0066.2	521.0070.2
FRG44	521.0066.2	521.0070.2

SPARE SPRING

FRG11	008.0282.1
FRG12	008.0282.1
FRG13	008.0282.1
FRG14	008.0282.1
FRG22	008.0269.1
FRG23	008.0269.1
FRG24	008.0269.1
FRG31	008.0275.1
FRG32	008.0275.1
FRG33	008.0275.1
FRG34	008.0275.1
FRG41	008.0283.1
FRG42	008.0283.1
FRG43	008.0283.1
FRG44	008.0283.1

SPARE PARTS ELEMENTS

(For filling up see table “Ordering and option chart”)

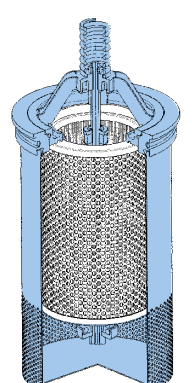
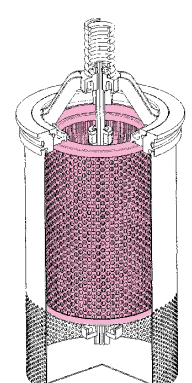
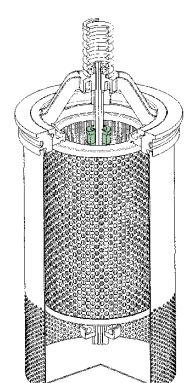
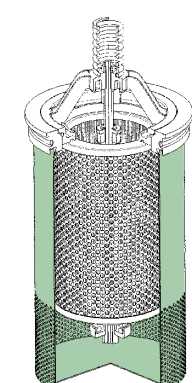
FILTER HOUSING	FILTER ELEMENT	ACCESSORY	ACCESSORY
			
<input type="checkbox"/>	<input type="checkbox"/>	<input type="checkbox"/>	<input type="checkbox"/>
		MAGNETIC CORE	DIFFUSOR

BRG T O I F X X

ERF

MAGNETIC CORE

DIFFUSOR



Is this datasheet the latest release? Please check on our website.

